



 www.nilight.com
 headlight@nilight.com
 (844)645-4448



INSTRUCTION MANUAL LED LIGHTING

 www.nilight.com
 headlight@nilight.com
 (844)645-4448

»» PRE-INSTALLATION NOTICE

- ◆ Please make sure this product has been purchased from a legal sales channel.
- ◆ This product can only be used on road-legal automotive vehicles.
- ◆ This product may contain small parts, and we strongly advise you to keep this product away from infants and children, so as to prevent a choking hazard or possible injury.
- ◆ Please test the LED bulbs before fully installing them in your vehicle.
- ◆ Before installing, please make sure the LED bulbs are not damaged or broken, and have not been dropped on the ground. If any of these conditions exist, please do not install the LED bulbs in your vehicle.
- ◆ Store this product only in a cool and dry place. Keep away from moisture and dust, otherwise it may become damaged.
- ◆ Keep the LED bulb away from areas or materials that are exposed to flames or prone to combustion.

*Please read this instruction manual carefully before installing this product. After completing the installation, please keep this manual in a safe place for future reference.

»» LIGHTING TEST

1. Remove the original bulb from the vehicle connector.
2. Attach the LED bulb connector to the vehicle connector.
3. Turn on the LED bulb and test for correct lighting.
4. Check if any warning signs show up on the vehicle dashboard. If no warnings occur, the test is finished.

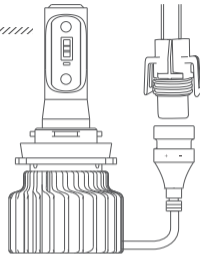

NOTE: If one of the LED bulbs does not work, it could be attributed to poor contact. Make sure the connection is good. If the problem cannot be solved, swap the left side bulb with the right side bulb and test again.

WARNING:

- ◆ Please wear work gloves during installation.
- ◆ Do not switch on the LED bulb until the connection is finished.
- ◆ If the LED bulb flashes or warnings show up on the vehicle dashboard, please connect the resistors (CANbus) to ensure correct operation.
- ◆ If any problems still cannot be resolved under the guidance of this manual, please feel free to contact our customer support team.

»» PRECAUTIONS FOR INSTALLATION

- ◆ Please wear work gloves during the installation.
- ◆ Be sure not to touch the LED element of the LED bulb.
- ◆ Prevent any type of oil, dirt or moisture from adhering to the product, so as to prevent a potential failure.
- ◆ Bulb installation should be done safely in environments where a large amount of space is available. Before installation, stop the vehicle engine, apply the parking brake, place the shift in the park or neutral position, and remove the key.
- ◆ Be sure not to apply excessive force to the LED bulb during installation. If damage occurs, it may cause a lighting malfunction and other potential failures.
- ◆ After installation, please check whether the high and low beams and other electrical equipment on the dashboard work normally and no warnings occur.
- ◆ Do not bend the cables excessively, especially near the heat sink area.

»» WARNINGS FOR USE

- ◆ Do not look directly at the operating lamp for any period of time, as this may cause serious eye injury.
- ◆ Do not disassemble or modify the product in any way, as this may damage the product or cause fire and/or personal injury.
- ◆ If there is any abnormal vibration or sound when the vehicle is moving, stop immediately in a safe location and check the vehicle.
- ◆ Do not wash the vehicle with the lights turned on, as sudden changes in temperature may cause an unexpected reaction from the LED bulb.
- ◆ The LED bulb body and LED surface can reach very high temperatures. Do not touch the area with hands or allow any skin contact as it may result in severe burns.
- ◆ During heavy rain or when putting the vehicle through a car wash, condensation may build up inside the bulb compartment due to the difference in temperatures inside and outside the bulb compartment. Please note that this will not affect the overall function of the LED bulb.

PRODUCT PARTS INTRODUCTION

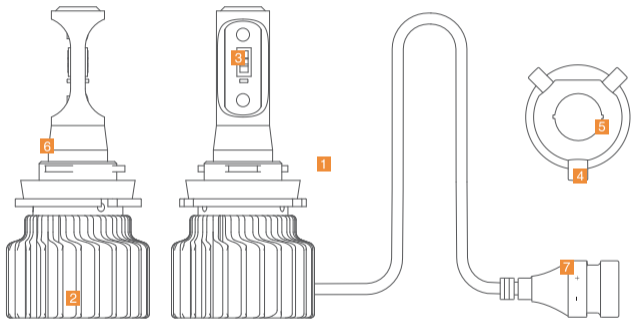

- 1. Locking Ring
- 2. Heat Sink
- 4. Tab (locking ring)
- 6. Tab (LED bulb)

- 3. LED Component
- 5. Groove (locking ring)

- 7. Bulb Connector

INSTALLATION - H4/H13/9004/9007

NOTE: Please keep the LEDs as shown in the picture for proper installation.

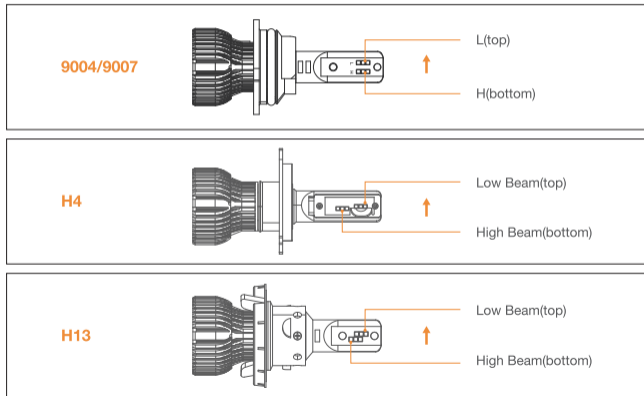

INSTALLATION - H4

1. Removing the vehicle's rubber cover and original bulb.

- ① Disconnect the vehicle connector.
- ② Remove the rubber cover.
- ③ Push down the bulb spring to release it.
- ④ Take out the original bulb.



2. Holding the bulb by the heat sink, twist the locking ring counter-clockwise until it unlocks, and then remove it.

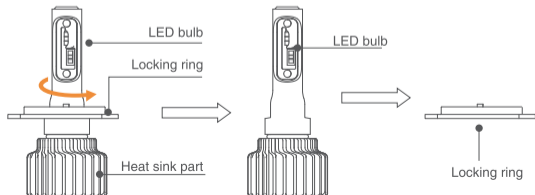

3. Install the locking ring to the vehicle's light housing and fix it in place using the bulb spring.

NOTE: When installing the locking ring section to the vehicle's light housing, be very careful not to drop the locking ring inside the housing.

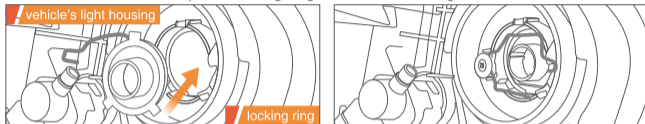

4. Put the original rubber cover into the vehicle's light housing and secure it in place.

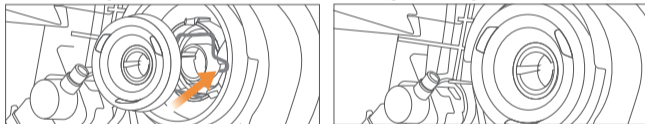

5. Insert the LED bulb through the secured locking ring. Line up the tab parts of the LED bulb with the groove sections of the locking ring.

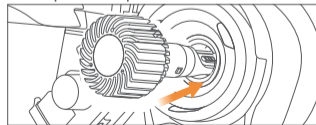

LOCKING RING: **LED BULB:**



6. While pressing the bulb down, turn it clockwise until it does not turn anymore and then lock the LED bulb in place.

(Please make sure the LED bulb is installed in the correct position.)

The LED bulb should be installed so that the flat sides of the bulb containing the LED elements are facing 3 and 9 o'clock, respectively.

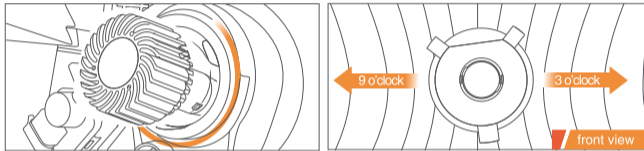

7. Connect the LED bulb's connector with the original vehicle connector.

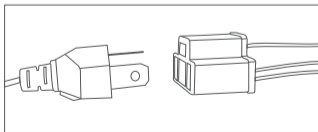

INSTALLATION - 9004/9007

1. Removing the vehicle's original bulb.

- ◆ Push down the knob on the connector and disconnect the two parts.
- ◆ Rotate counterclockwise and remove the vehicle's original bulb holder.
- ◆ Remove the original bulb.



2. Holding the bulb by the heat sink, twist the locking ring counter-clockwise until it unlocks, and then remove it.

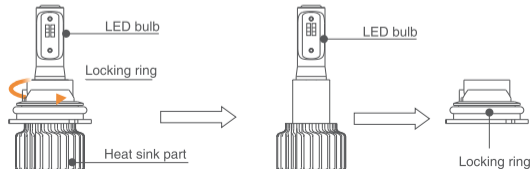

3. Install the locking ring to the vehicle's light housing and lock it in place.

NOTE: When installing the locking ring section to the vehicle's light housing, be very careful not to drop the locking ring inside the housing.

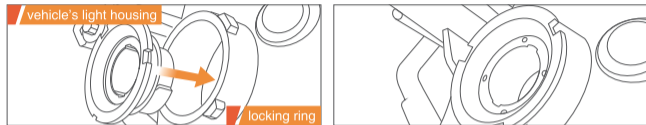

4. Insert the vehicle's original light holder into the vehicle's housing, rotate clockwise and lock it in place.



5. Insert the LED bulb through the secured locking ring.
Line up the tab parts of the LED bulb with the groove sections of the locking ring.

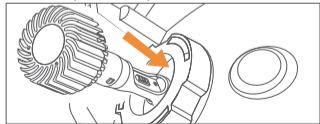

LOCKING RING: LED BULB:

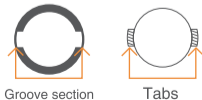

6. While pressing down the LED bulb, turn it clockwise until it does not turn anymore and then lock the LED bulb in place. (Please make sure the LED bulb is installed in the correct position.)

The LED bulb should be installed so that the flat sides of the bulb containing the LED elements are facing 3 and 9 o'clock, respectively.

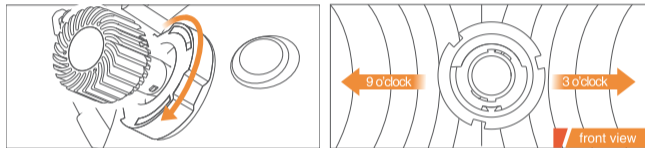

7. Connect the LED bulb's connector with the original vehicle connector.

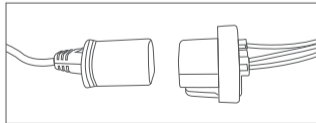

» INSTALLATION - H1/H3/H7

1. Removing the vehicle's rubber cover and original bulb.

- ① Remove the rubber cover.
- ② Disconnect the vehicle connector.
- ③ Push down the bulb spring to release it.
- ④ Take out the original bulb.



2. Holding the bulb by the heat sink, twist the locking ring counter-clockwise until it unlocks, and then remove it.

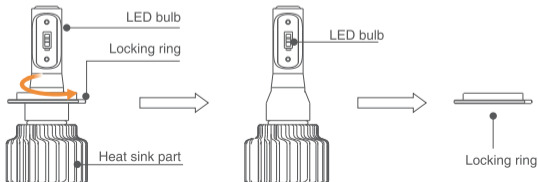

3. Install the locking ring to the vehicle's light housing and fix it in place using the bulb spring.

NOTE: When installing the locking ring section to the vehicle's light housing, be very careful not to drop the locking ring inside the housing.

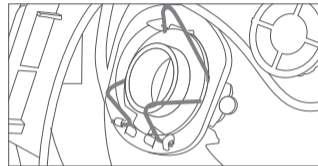

4. Insert the LED bulb through the secure locking ring. Line up the tab parts of the LED bulb with the groove sections of the locking ring.

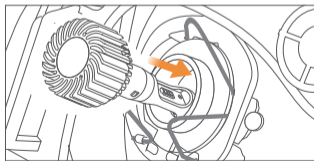

LOCKING RING:



Groove section

LED BULB:



Tabs

5. While pressing down the LED bulb, turn it clockwise until it does not turn anymore and then lock the LED bulb in place.
The LED bulb should be installed so that the flat sides of the bulb containing the LED elements are facing 3 and 9 o'clock, respectively.

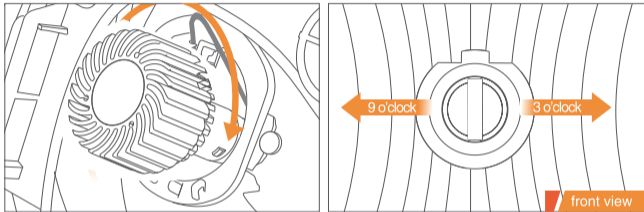

6. Connect the LED bulb's connector with the original vehicle connector, then reinstall the rubber cover.

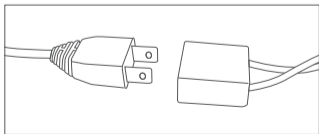

INSTALLATION - H8/H9/H10/H11/H13/H16/9005/9006/9012

1. Removing the original rubber cover and original bulb.
 - ◆ Remove the rubber cover (if present).
 - ◆ Push down the knob on the connector and disconnect the two parts.
 - ◆ Turn the bulb counter-clockwise and remove the original bulb.

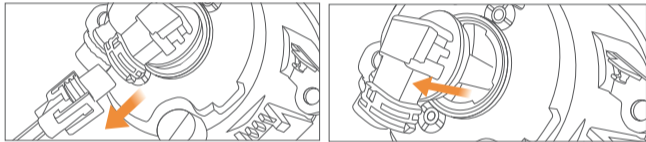

2. Insert the bulb into the light housing.
Line up the tab parts of the locking ring with the locking grooves of the light housing.

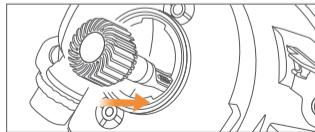

LOCKING RING: LIGHT HOUSING:

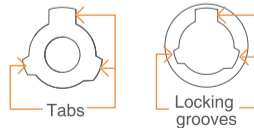

3. While pressing down the LED bulb, turn it clockwise until it does not turn anymore and then lock the LED bulb in place.

The LED bulb should be installed so that the flat sides of the bulb containing the LED elements are facing 3 and 9 o'clock, respectively.

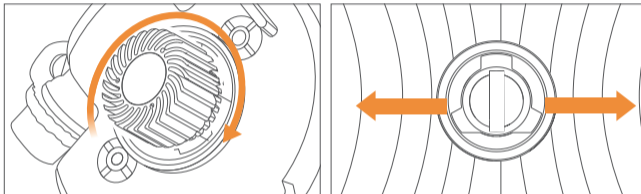

4. Connect the LED bulb's connector with the original vehicle connector, then reinstall the rubber cover (if present).

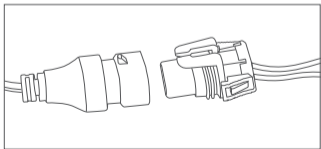

» TROUBLESHOOTING

<p>The lights do not work properly</p>	<ol style="list-style-type: none"> 1. Check if the power connectors are properly connected, and make sure that the vehicle headlight switch is in the "ON" position. 2. Make sure that the vehicle has enough battery to supply power to the LED bulb. 3. Install the LED bulbs with the resistors (CANbus).
<p>One of the bulbs is not working</p>	<p>Make sure the connection is good. If one of the bulbs still doesn't work, swap the left and right side bulbs and test again. If the problem cannot be resolved, it may be caused by the vehicle's light assembly.</p>
<p>The lights flicker or flash</p>	<p>Install the LED bulb with the resistors (CANbus) to resolve the issue.</p>
<p>A warning lamp appears on the vehicle's system dashboard</p>	<p>This is a harmless side-effect of the low-wattage LED bulbs not being recognized by the vehicle's system and can be resolved with the installation of an additional set of resistors (CANbus).</p>

How to align and aim LED headlight bulbs for the brightest light output

Keeping the LED chips horizontally aligned at the 3 and 9 o'clock positions to ensure a perfect beam pattern. However, for some vehicles, it is impossible to adjust to this position. As long as the beam pattern is correct, there is no need to rotate the position of the LED chips to 3 and 9 o'clock.

» NOTICE

1. The resistor (CANbus) is polarity sensitive. If the LED bulbs do not function properly after installation please reverse the resistor (CANbus) male connector 180 degrees and try again.
2. If the problem still cannot be resolved after using the resistors (CANbus) or if you have any questions, please contact our customer support team.

» DISCLAIMER

Nilight does not warranty its goods against any defect or damage caused by transportation, storage, improper installation and maintenance, internal or external hostile environments, misuse, abuse, negligence, accident, modification, tampering, the attachment of any unauthorized accessory, alteration to the goods, poor workmanship, or any other conditions whatsoever that cause a defect or failure of the product.

Nilight's sole responsibility under this warranty shall be, at its option, to either repair or replace any goods which fail during the warranty period, provided that the buyer has promptly reported the said failure to Nilight in writing, and complies with the provisions of this warranty.

» PRODUCT SPECIFICATIONS

Model	9005/9006/H11/H7/9012/H4/H13/9004/9007
LED Chip	SEOUL Y19 CSP
Operating Voltage	DC 9-16V
Color Temperature	6000K
Operating Temperature	-40 C to +85 C
Heat Sink Material	6063 Aluminum Heatsink
Cooling	Fan
Lifespan	50,000 Hours